

## Distribution Systems

### Distributors

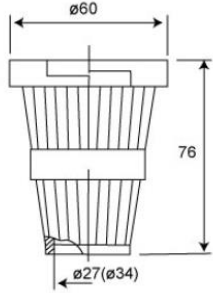

注: IPSI=0.007Mpa, 1GPM=227L/H

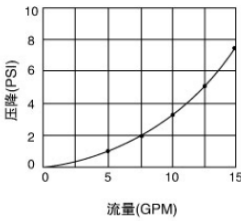

MT-H2805

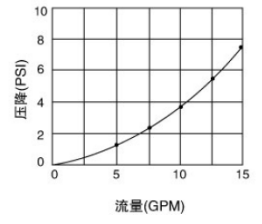
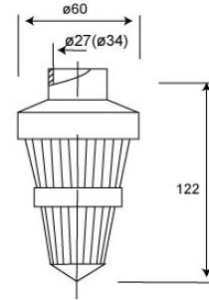

MT-H2807

Product Code	Specification	Tanks
MT-H2805	3/4" Top distributor for Fleck	6" -12" /Ø150-300mm
MT-H2807	3/4" Bottom distributor for Fleck	6" -12" /Ø150-300mm

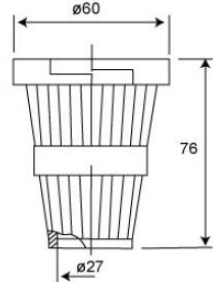

注: IPSI=0.007Mpa, 1GPM=227L/H

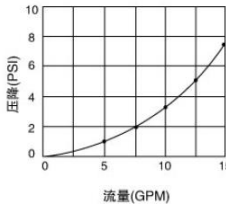

MT-H2805NT

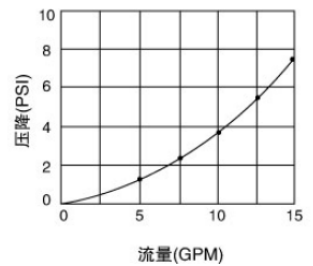
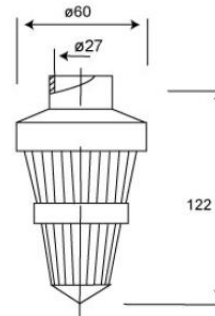

MT-H2807NT

Product Code	Specification	Tanks
MT-H2805-NT	3/4" Top distributor for Fleck	6" -12" /Ø150-300mm
MT-H2807-NT	3/4" Bottom distributor for Fleck	6" -12" /Ø150-300mm

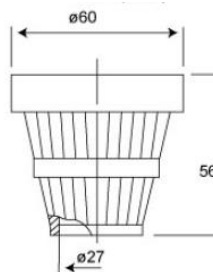

注: IPSI=0.007Mpa, 1GPM=227L/H

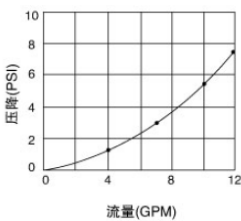

MT-H2801-A

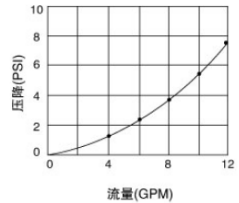
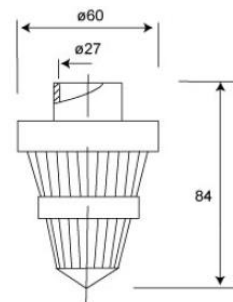

MT-H2803

Product Code	Specification	Tanks
MT-H2801-A	3/4" Top distributor for Autotrol	6" -12" /Ø150-300mm
MT-H2803	3/4" Bottom distributor for Autotrol	6" -12" /Ø150-300mm

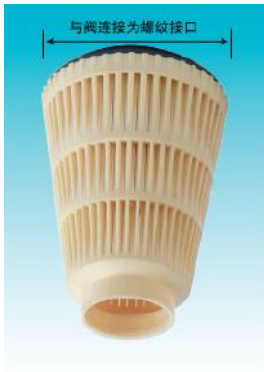

MT-HD219

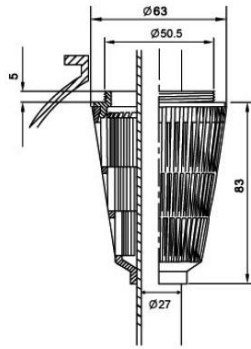

MT-HD239

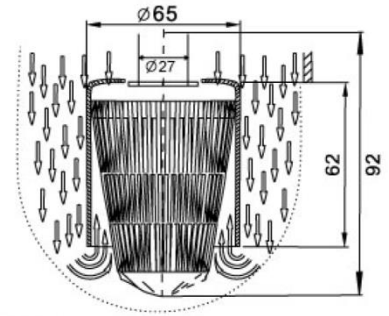

Product Code	Specification	Tanks
MT-HD219	3/4" Top distributor threaded type	6" -12" / $\phi 150$ -300mm
MT-HD239	3/4" Bottom distributor glue type	6" -12" / $\phi 150$ -300mm



MT-H2809

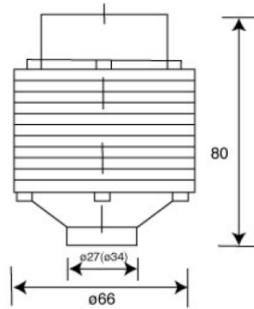

MT-H2810

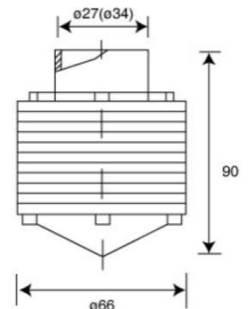

Product Code	Specification	Tanks
MT-H2809	3/4" Top distributor stack	8" -16" /@200-400mm
MT-H2809-GT	3/4" Top distributor stack, glue type	8" -16" /@200-400mm
MT-H2810	3/4" bottom distributor stack	8" -16" /@200-400mm



MT-HD232/ MT-HD233

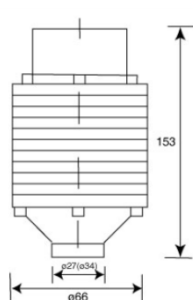

MT-H2809-L, MT-H2810-L

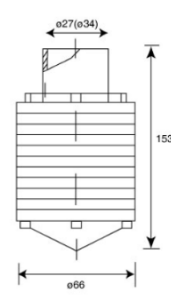

Product Code	Specification	Tanks
MT-H2809-L	3/4" Top distributor stack L type	6" -16" /@150-400mm
MT-H2810-L	3/4" bottom distributor stack L type	6" -16" /@150-400mm
MT-HD232	1" Top distributor stack	8"-20"/@200-500mm
MT-HD233	1" bottom distributor stack	8"-20"/@200-500mm



MT-H182

MT-H182-1

MT-H2808

Product Code	Specification	Tanks
MT-H182	1.5" top distributor stack	12"-36"/@300-910mm
MT-H182-1	1.5" top distributor stack	12"-36"/@300-910mm
MT-H2808	1.5" bottom distributor stack	12"-36"/@300-910mm

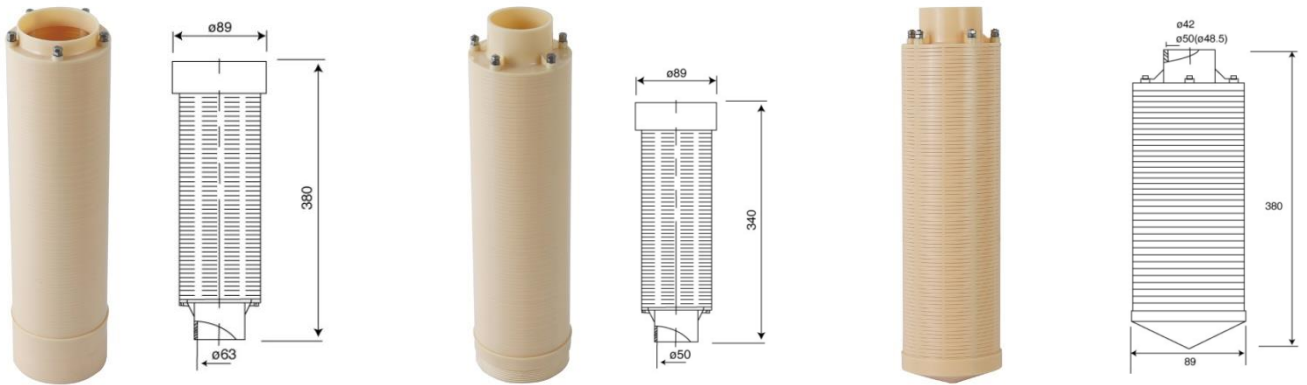

MT-HD234

MT-HD216

MT-H182-1L

Product Code	Specification	Tanks
MT-HD234	2" top distributor stack for Fleck 3150	30"-60"/@750-1500mm
MT-HD216	1.5" top distributor stack for Runxin valves	30"-60"/@750-1500mm
MT-H182-1L	1.5" bottom distributor stack L type	24"-40"/@600-1000mm

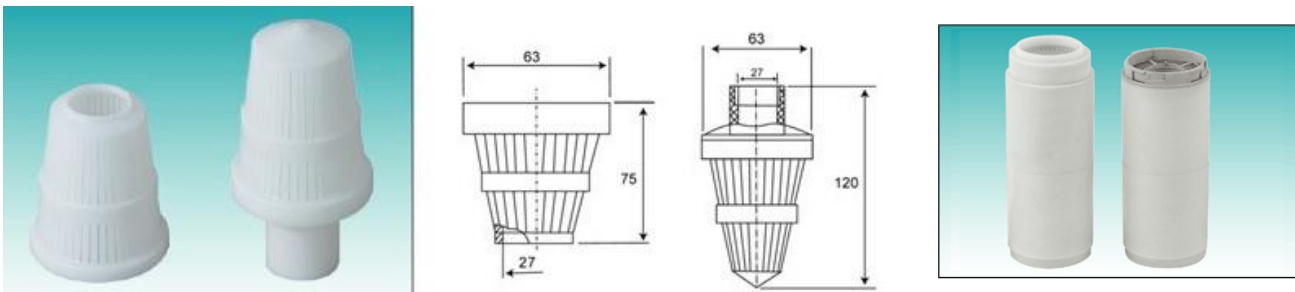

MT-HD203 MT-HD204

KDF-225

Product Code	Specification	Tanks
MT-HD203	3/4" Top distributor glue type	6" -12" /Ø150-300mm
MT-HD204	3/4" Bottom distributor glue type	6" -12" /Ø150-300mm